

labmodul

Designing safety

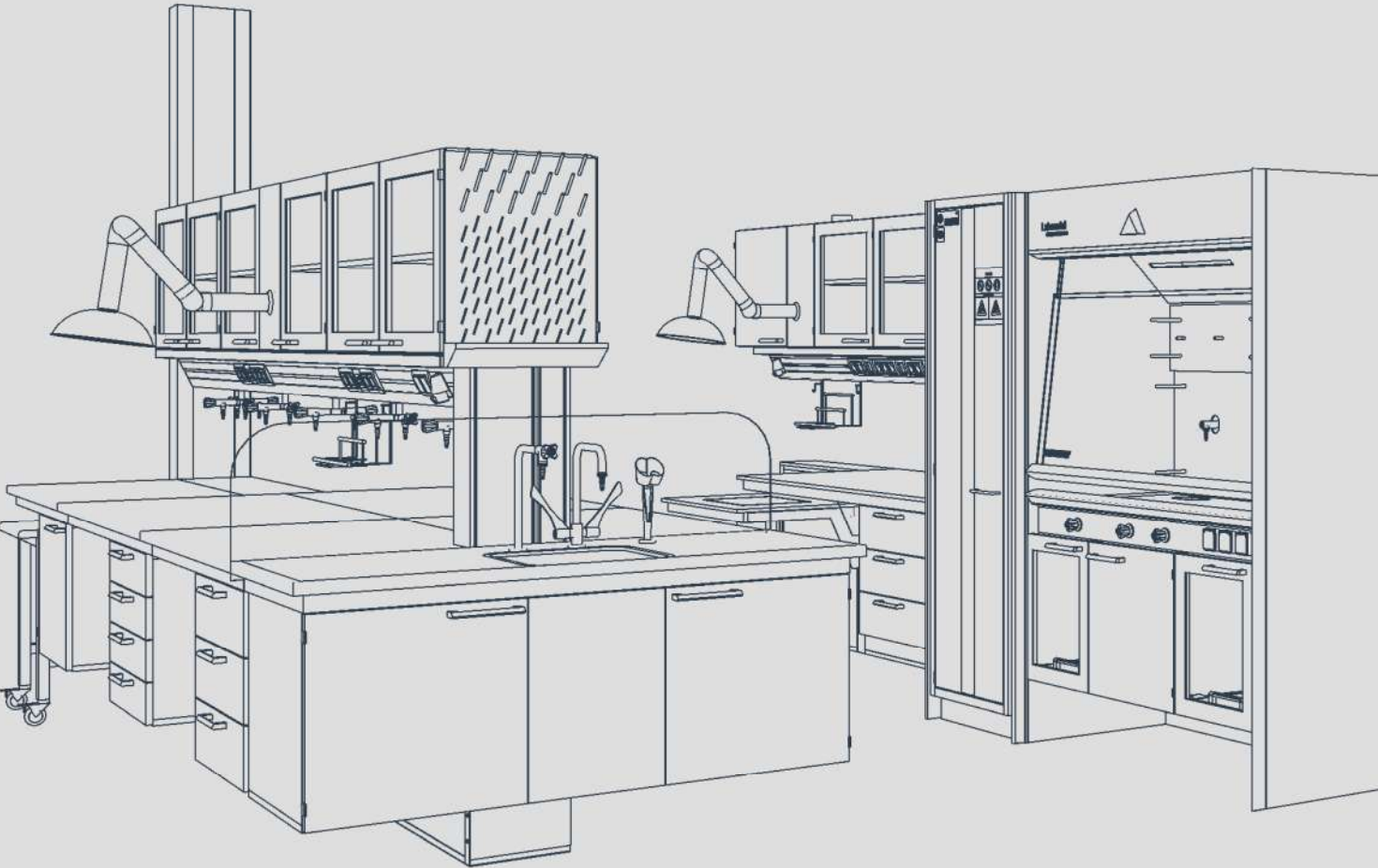

Designing safety...



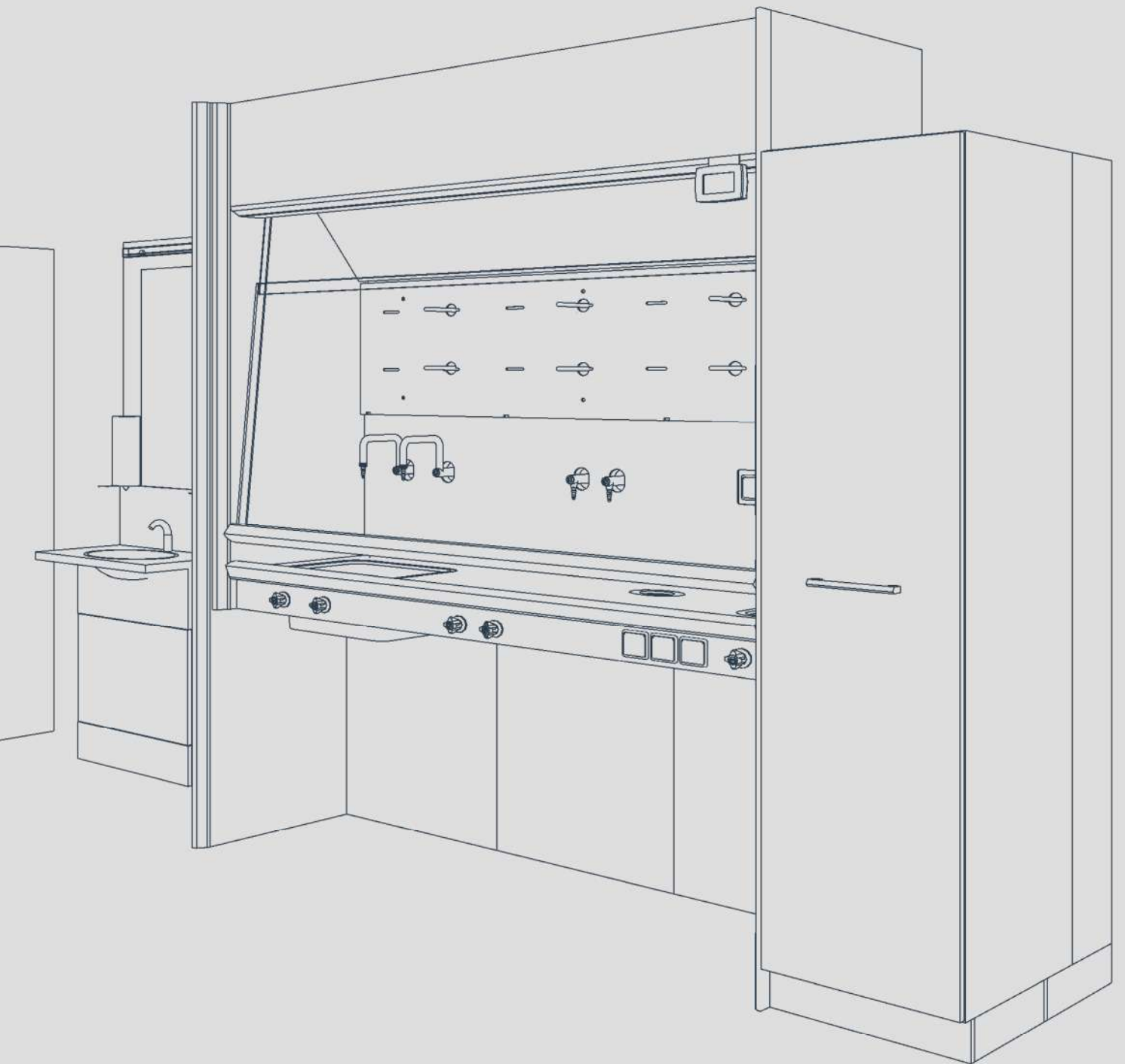





Worktops, Materials Fronts, Profiles, and Sinks



Worktops, Fronts Colors and Profiles

Worktop colors	White	Light grey	Black	Brushed steel	Beige
Laminated worktops					
Compact laminate					
Stainless steel					
Epoxy Resin					
Ceramic					
Polypropylene					

Fronts

Material options

- Laminate
- Compact laminate

Front colors



Plinth

- Two standard colors.

Plinth colors



Worktop profiles

Front edge

Rear edge

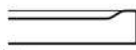
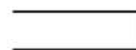



Standard Color
A fee may be added for other colors

Worktop materials	Ceramic	Epoxy resin	Polypropylene(PP)	Stainless steel(316)	Compact laminate	Laminate
Acid, base	○	○	○	○	○	○
Organic solvents	○	○	○	○	○	○
Discoloration	○	○	○	○	○	○
Heat resistance	○	○	○	○	○	○
Absorption	○	○	○	○	○	○
Compression	○	○	○	○	○	○
Impact effect	○	○	○	○	○	○
Surface uniformity	○	○	○	○	○	○

Excellent
Good
Acceptable

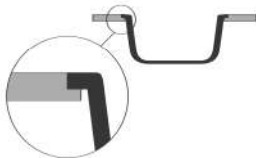

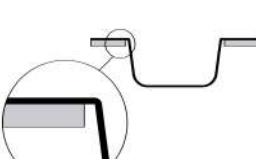
Sink installation	Ceramic	Epoxy resin	Polypropylene(PP)	Stainless steel(316)	Compact laminate	Laminate
 Drop-in sink	○	○			○	
 Undermount sink	○	○			○	
 Drop-on sink	○	○	○	○	○	○
 Welded in sink			○	○		

Sink worktops

Wash placement

A

B

C

Worktop materials

- 🔥 High-pressure laminate
- 🔥 Compact laminate
- 🔥 Polypropylene (PP)
- 🔥 Epoxy Resin
- 🔥 Acid resistant stainless steel ASI316
- 🔥 Ceramics



Drain plug 97B0070P



Overflow pipe 158mm 97B0158

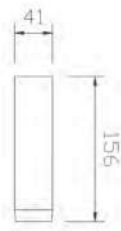

Water trap 97B0080

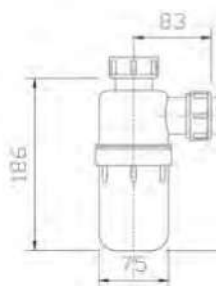

Polypropylene sinks

320 x 320 x 200 mm
400 x 300 x 250 mm
400 x 400 x 250 mm
500 x 400 x 250 mm
600 x 400 x 250 mm



Ceramic sinks

400 x 400 x 250 mm
500 x 400 x 250 mm
600 x 400 x 250 mm



Epoxy resin sinks

300 x 200 x 200 mm
356 x 254 x 157 mm
400 x 400 x 300 mm
406 x 305 x 203 mm
450 x 365 x 200 mm
600 x 450 x 300 mm
635 x 381 x 254 mm



Stainless steel sinks

340 x 300 x 145 mm
400 x 340 x 145 mm
480 x 340 x 180 mm
500 x 400 x 160 mm
600 x 400 x 200 mm

Fronts

- 🔥 High pressure laminate
- 🔥 Compact laminate
- 🔥 Linoleum
- 🔥 Corian



Glass cabinet fronts

- 🔥 Natural anodized 20 mm aluminum frame with 110° hinges
- 🔥 White powder-coated 20 mm aluminum frame with 110° hinges
- 🔥 Laminate 60 mm frame with 270° hinges
- 🔥 Laminate 60 mm frame concealed 110° hinges

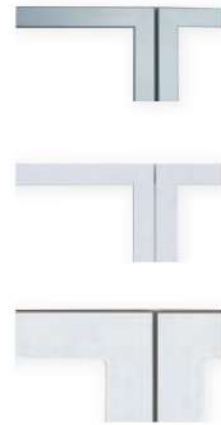

Handles

- 🔥 Standard logistics aluminum handles with an inclined surface, for example, Dymo strips. Width 190 mm
- 🔥 Handle in brushed stainless steel. Width 160 mm
- 🔥 Handle in matt aluminum. Width 160 mm



Top cabinet for wall hanging

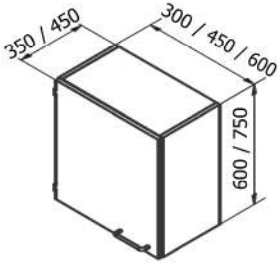

Cabinet with 1 solid door

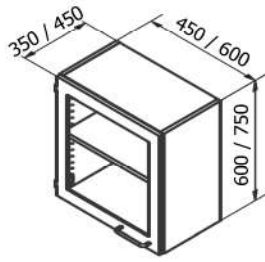

Cabinet with 1 laminated glass door

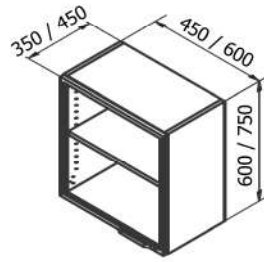

Cabinet with 1 aluminum frame glass door

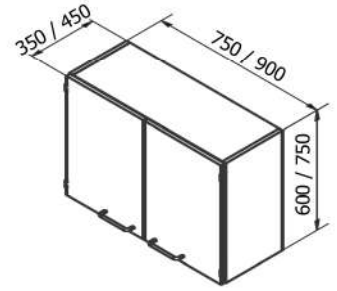

Cabinet with 2 solid door

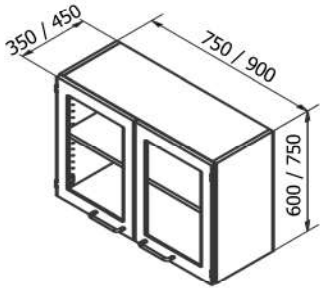

Cabinet with 2 laminated glass door

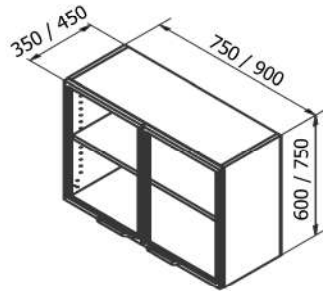

Cabinet with 2 aluminum frame glass door

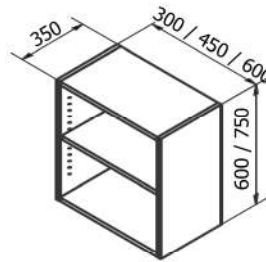

Top shelf cabinet - wall hanging

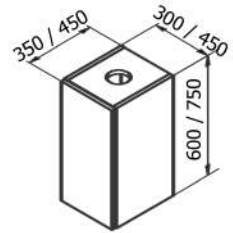

Exhaust cabinet - wall hanging

Top cabinet for Island bench - double sided

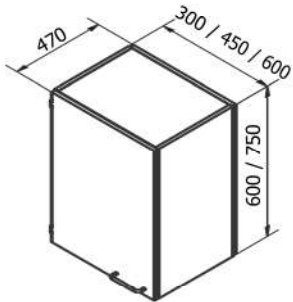

Cabinet with 1 solid door

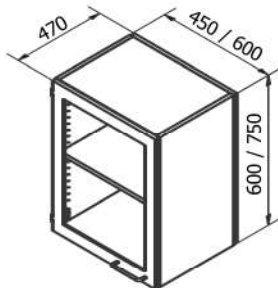

Cabinet with 1 laminated glass door

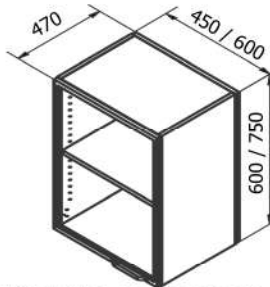

Cabinet with 1 aluminum frame glass door

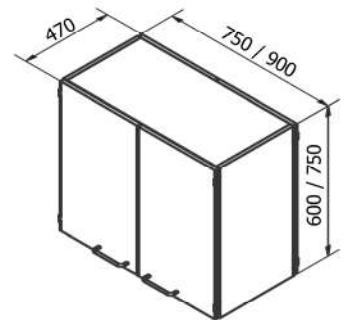

Cabinet with 2 solid door

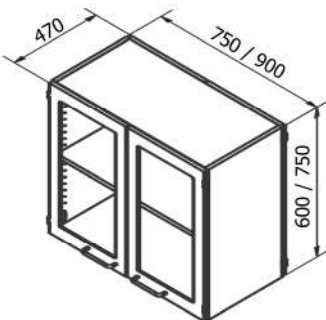

Cabinet with 2 laminated glass door

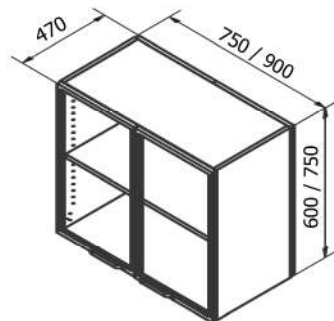

Cabinet with 2 aluminum frame glass door

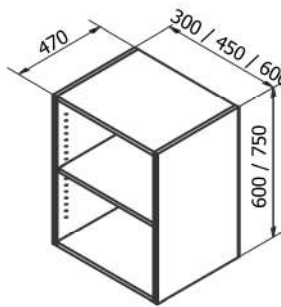

Top shelf cabinet - center bench

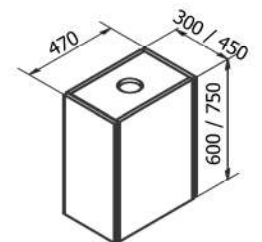

Exhaust cabinet - center bench

Mobile cabinet

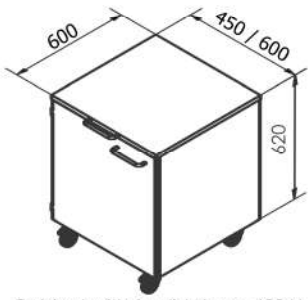

Cabinet with 1 solid door - 620 H

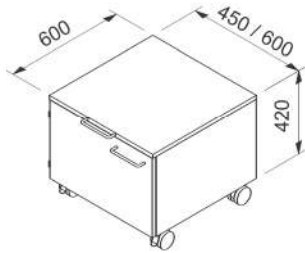

Cabinet with 1 solid door - 420 H

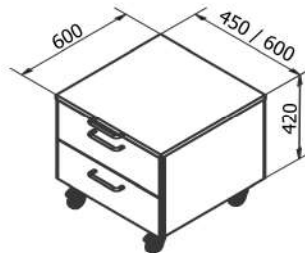

Cabinet with 2 drawers - kom. K



Cabinet with 2 drawers - kom. A

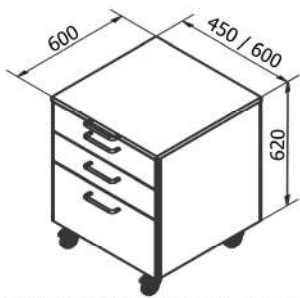

Cabinet with 2+1 drawers - kom. B

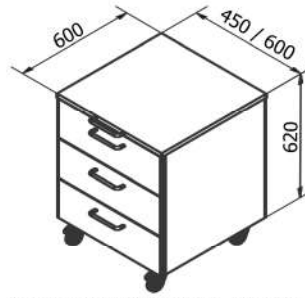

Cabinet with 3 drawers - kom. C

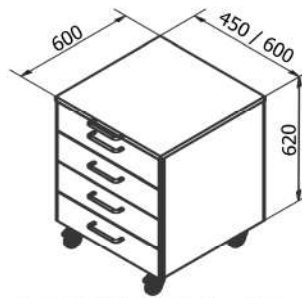

Cabinet with 4 drawers - kom. D





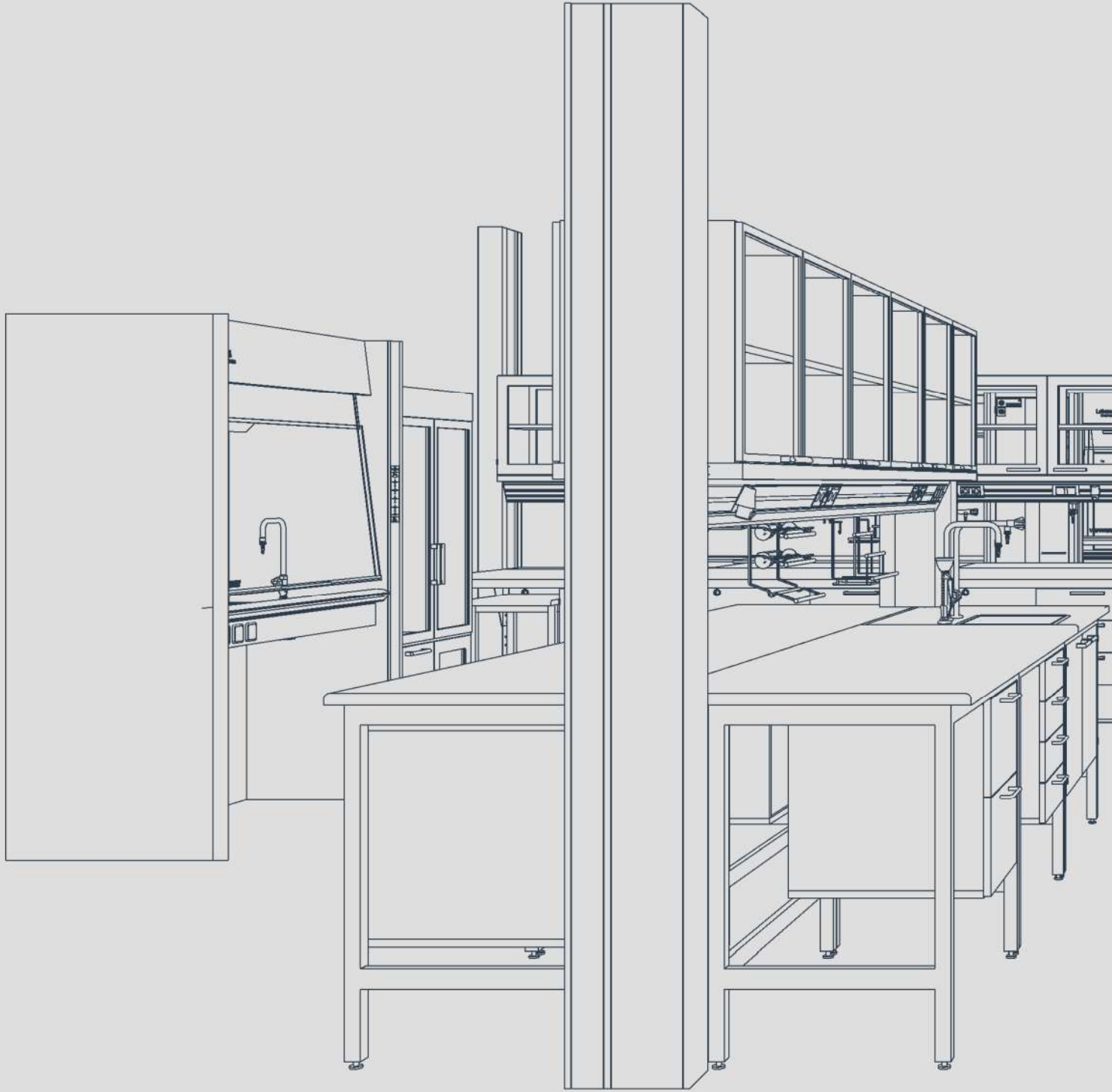





labmodul
Designing safety

Version: ★ ★ ★

LABMODUL A/S

Valhøjs alle 190
DK-2610 Rødovre
info@labmodul.dk